

BLOCK DE CONCRETO

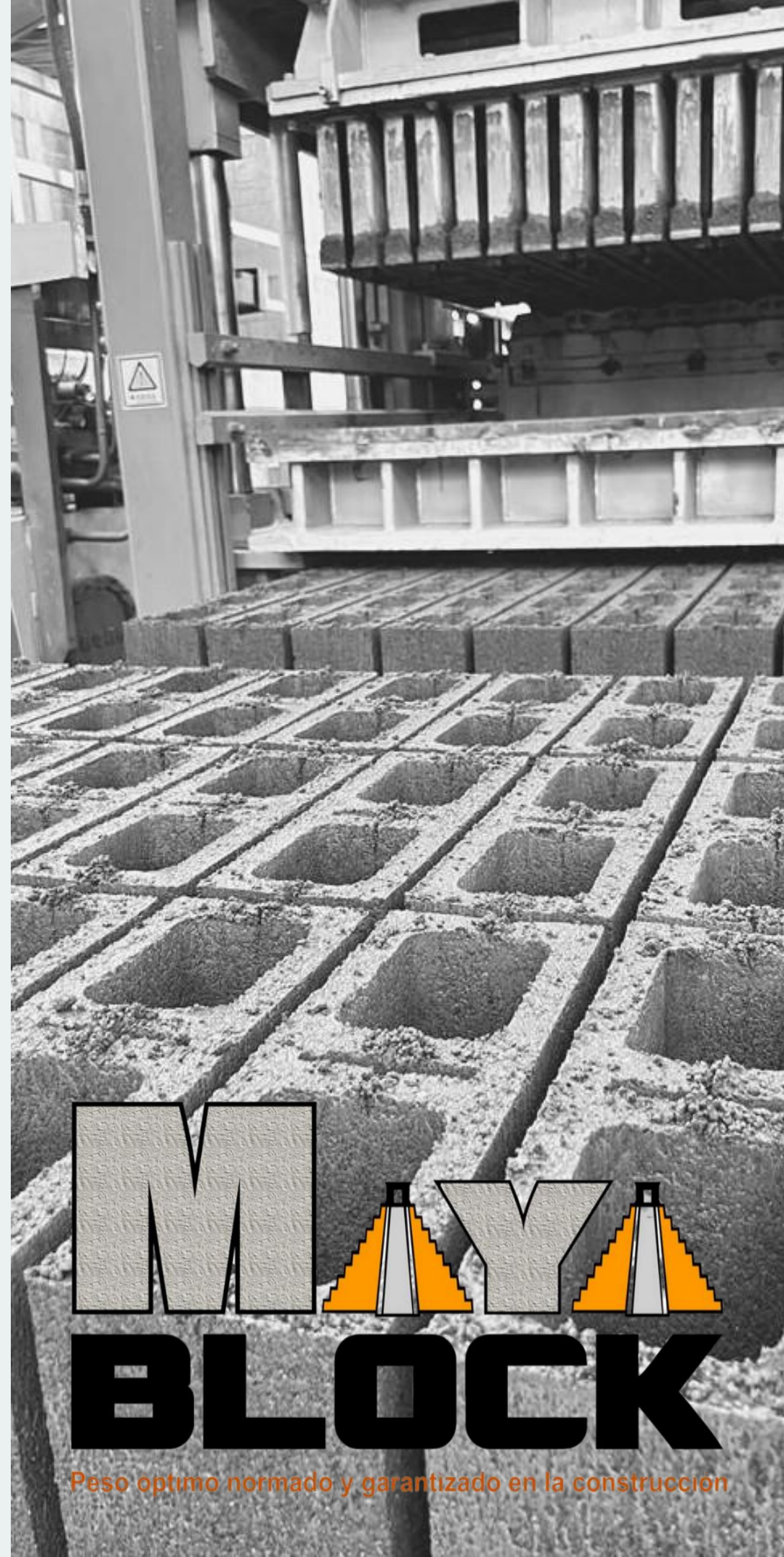

MAYY
BLOCK

Peso óptimo normado y garantizado en la construcción

CATÁLOGO 2023

M A Y A B L O C K S . A .

PRODUCTOS

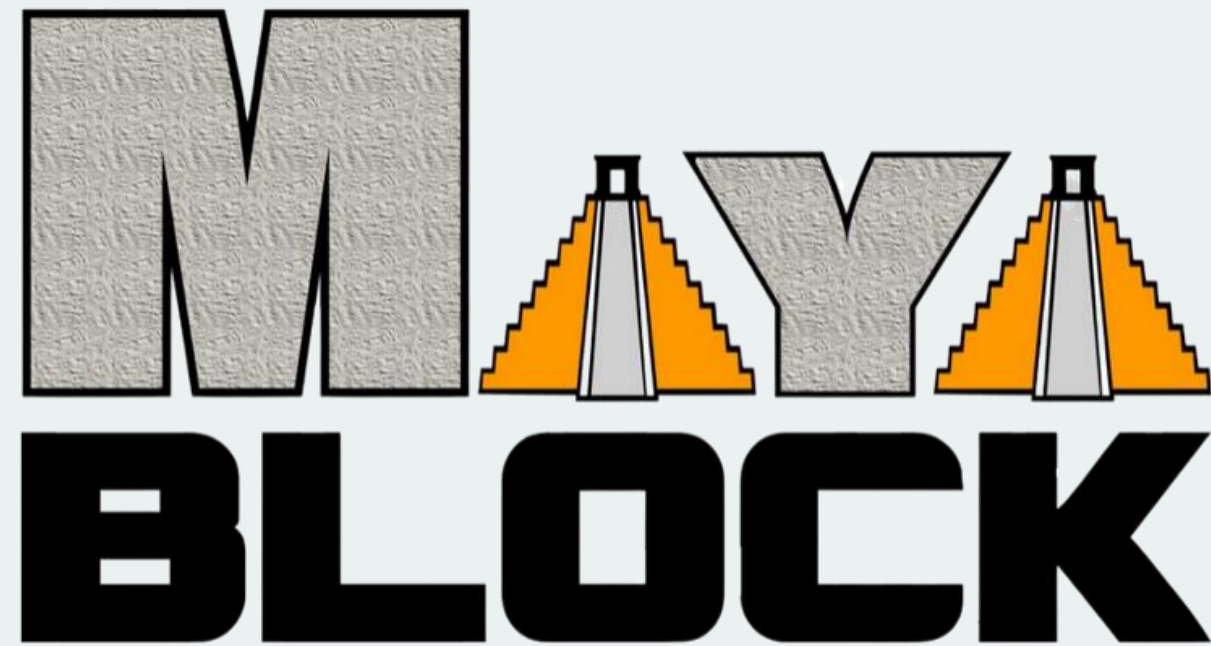

Peso óptimo normado y garantizado en la construcción

BLOCK CLASE A

BLOCK CLASE B

BLOCK CLASE C

BLOCK SOLERA

BLOCK TABIQUE

BLOCK CONVENCIONAL



M A Y A B L O C K S . A .

BLOCK CLASE A

Datos Técnicos

<i>Dimensiones</i>	<i>14x19x39 cm.</i>
<i>Resistencia área Bruta</i>	<i>70 kg/cm²</i>
<i>Resistencia área Neta</i>	<i>133 kg/cm²</i>

Envío

	<i>camión un eje</i>	<i>1,000 unidades</i>
	<i>camión doble eje</i>	<i>1,500 unidades</i>
	<i>Rastra</i>	<i>3,500 unidades</i>

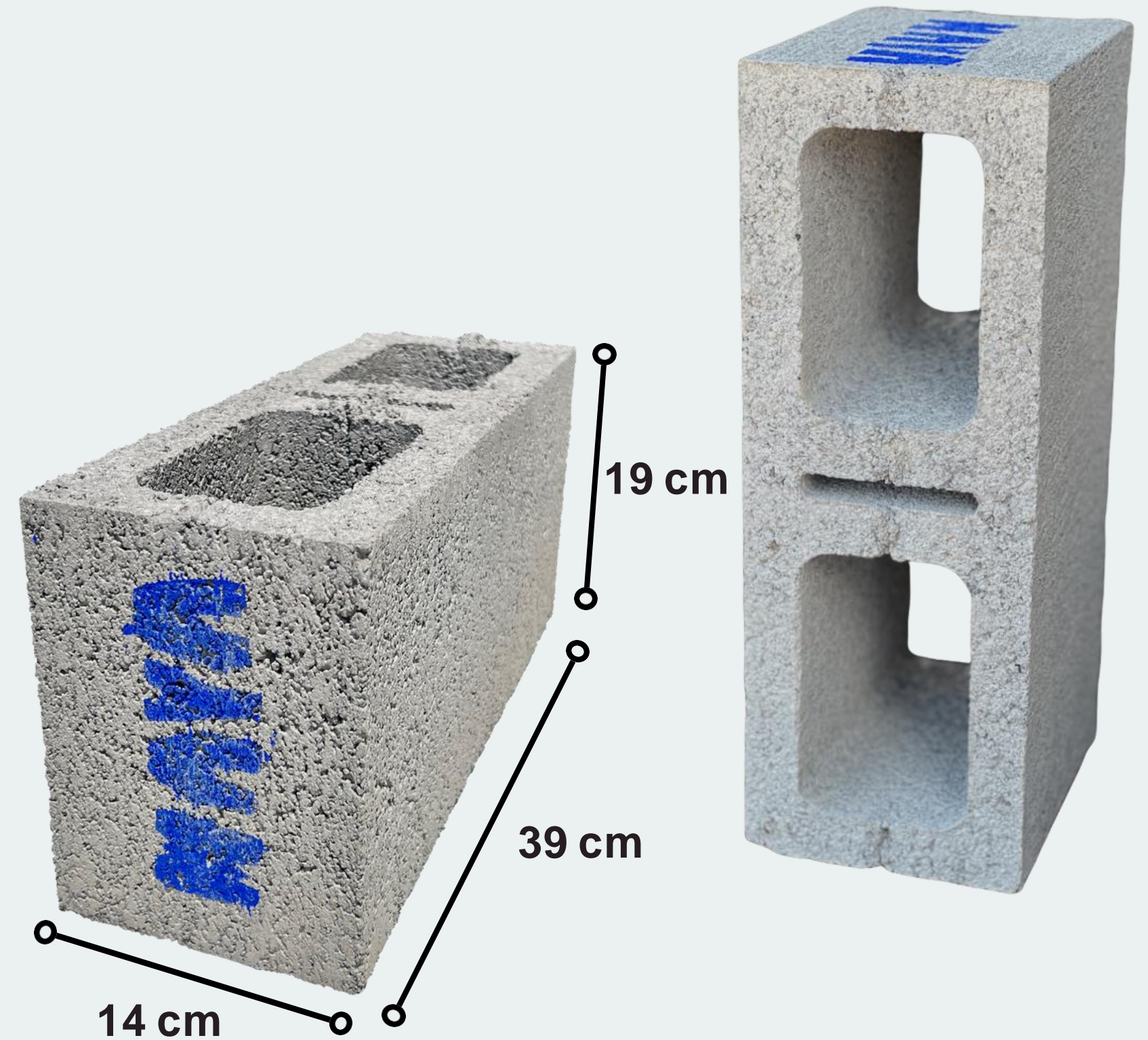



M A Y A B L O C K S . A .

BLOCK CLASE B

Datos Técnicos

<i>Dimensiones</i>	<i>14x19x39 cm.</i>
<i>Resistencia área Bruta</i>	<i>50 kg/cm²</i>
<i>Resistencia área Neta</i>	<i>100 kg/cm²</i>

Envío

	<i>camión un eje</i>	<i>1,000 unidades</i>
	<i>camión doble eje</i>	<i>1,500 unidades</i>
	<i>Rastra</i>	<i>3,500 unidades</i>

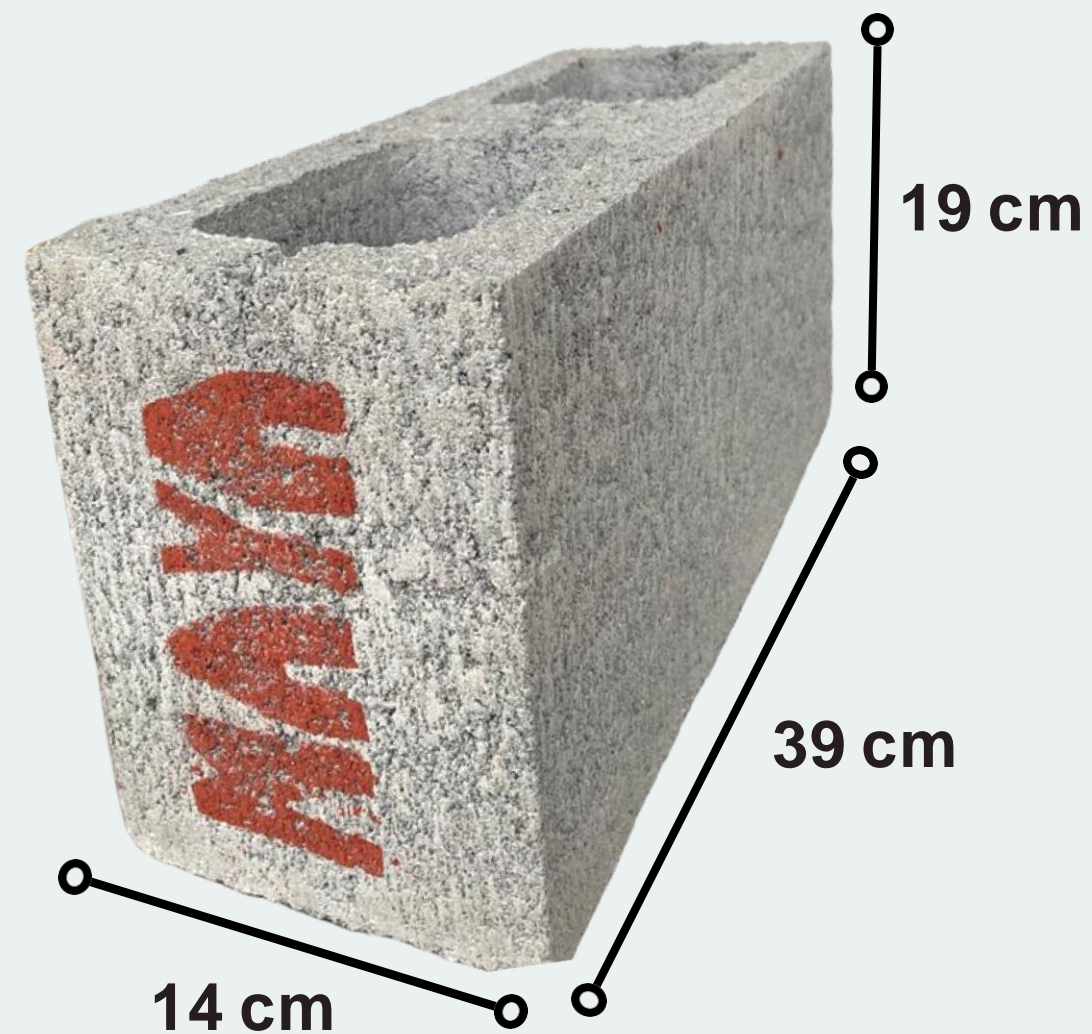



M A Y A B L O C K S . A .

BLOCK CLASE C

Datos Técnicos

<i>Dimensiones</i>	<i>14x19x39 cm.</i>
<i>Resistencia área Bruta</i>	<i>35 kg/cm²</i>
<i>Resistencia área Neta</i>	<i>66kg/cm²</i>

Envío

	<i>camión un eje</i>	<i>1,000 unidades</i>
	<i>camión doble eje</i>	<i>1,500 unidades</i>
	<i>Rastra</i>	<i>3,500 unidades</i>

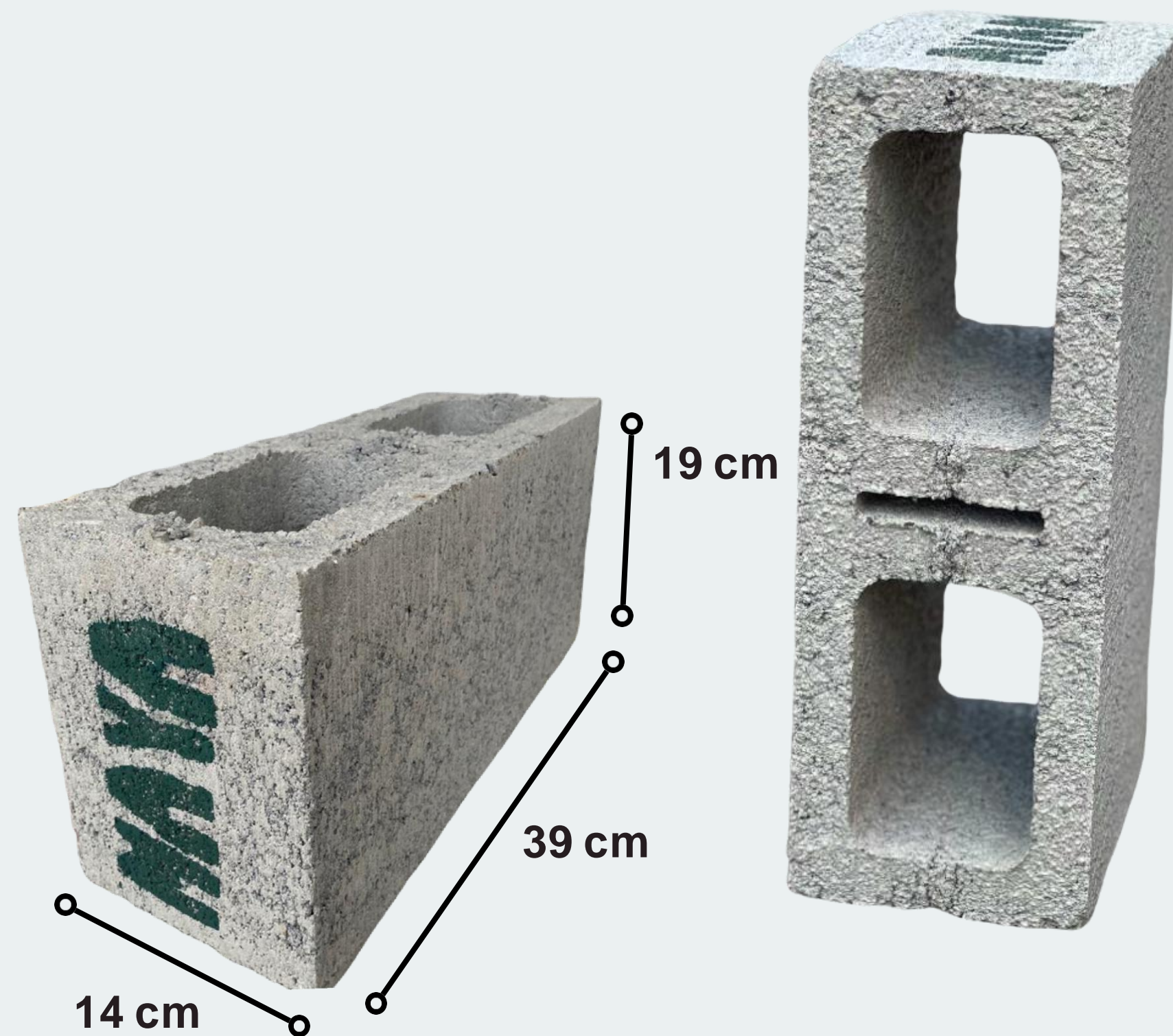

M A Y A B L O C K S . A .

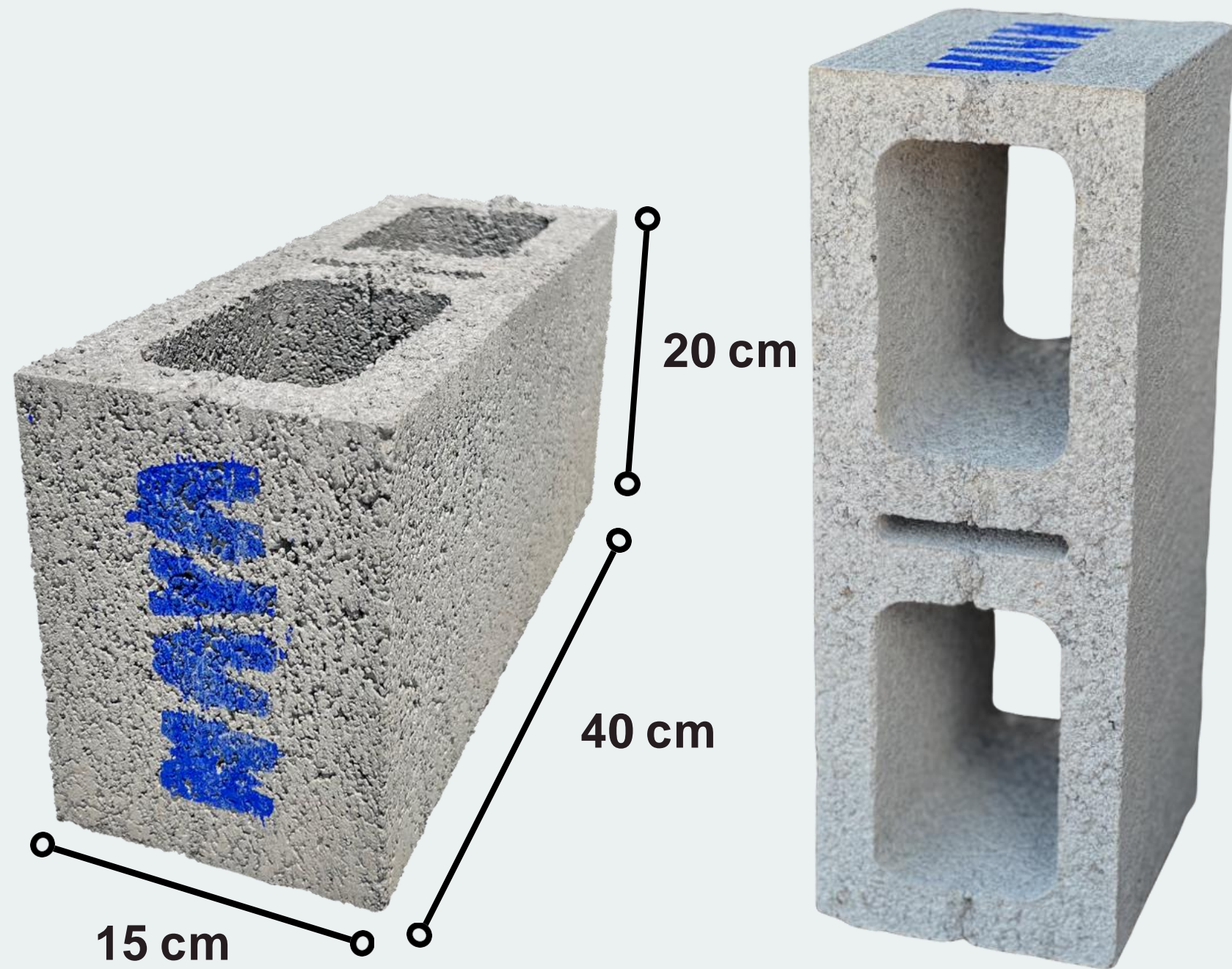

BLOCK CLASE A



Datos Técnicos

<i>Dimensiones</i>	15x20x40 cm.
<i>Resistencia área Bruta</i>	70 kg/cm ²
<i>Resistencia área Neta</i>	133 kg/cm ²

Envío

	<i>camión un eje</i>	1,000 unidades
	<i>camión doble eje</i>	1,500 unidades
	<i>Rastra</i>	3,500 unidades

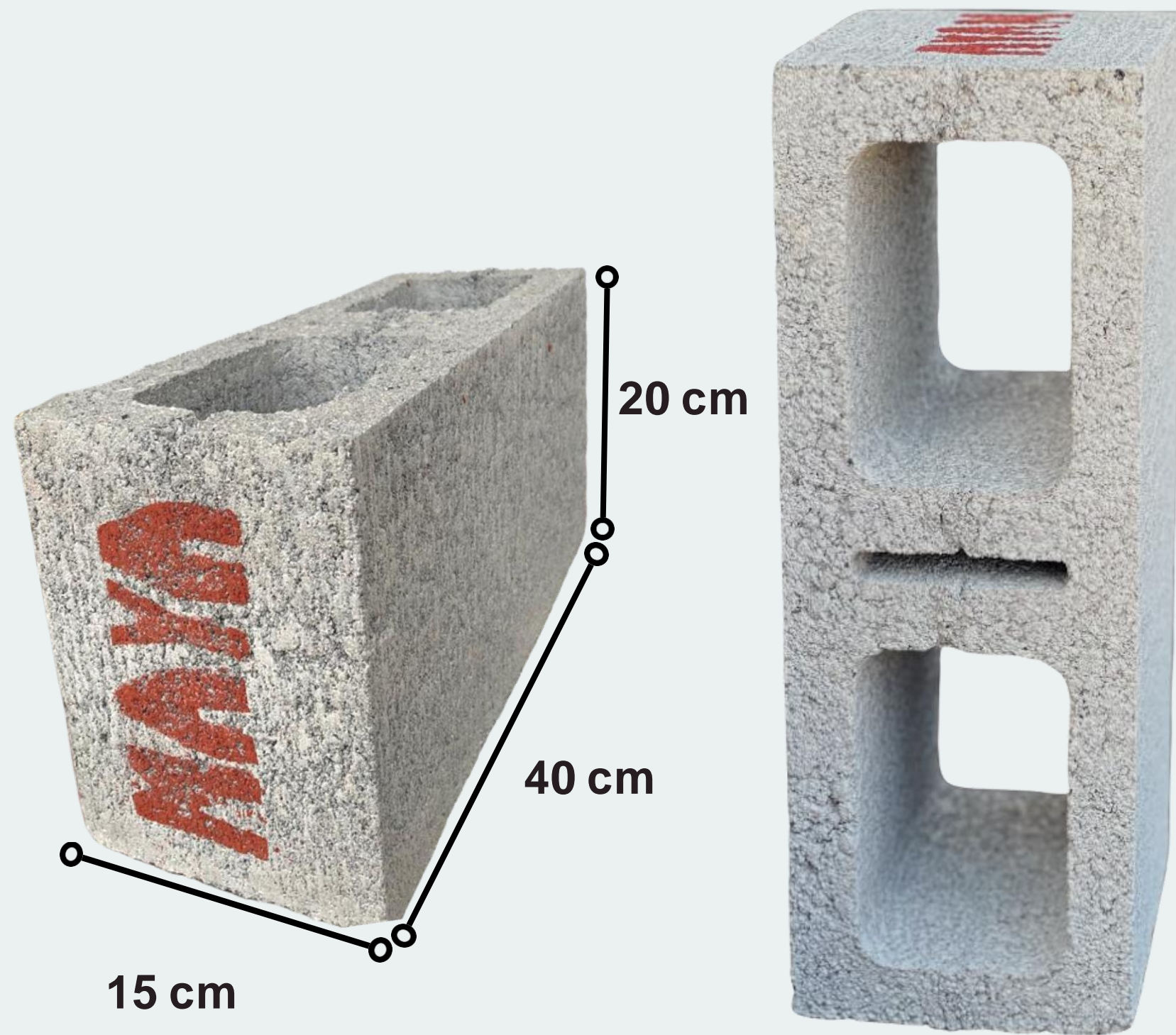

BLOCK CLASE B



Datos Técnicos

<i>Dimensiones</i>	<i>15x20x40 cm.</i>
<i>Resistencia área Bruta</i>	<i>50 kg/cm²</i>
<i>Resistencia área Neta</i>	<i>100 kg/cm²</i>

Envío

	<i>camión un eje</i>	<i>1,000 unidades</i>
	<i>camión doble eje</i>	<i>1,500 unidades</i>
	<i>Rastra</i>	<i>3,000 unidades</i>

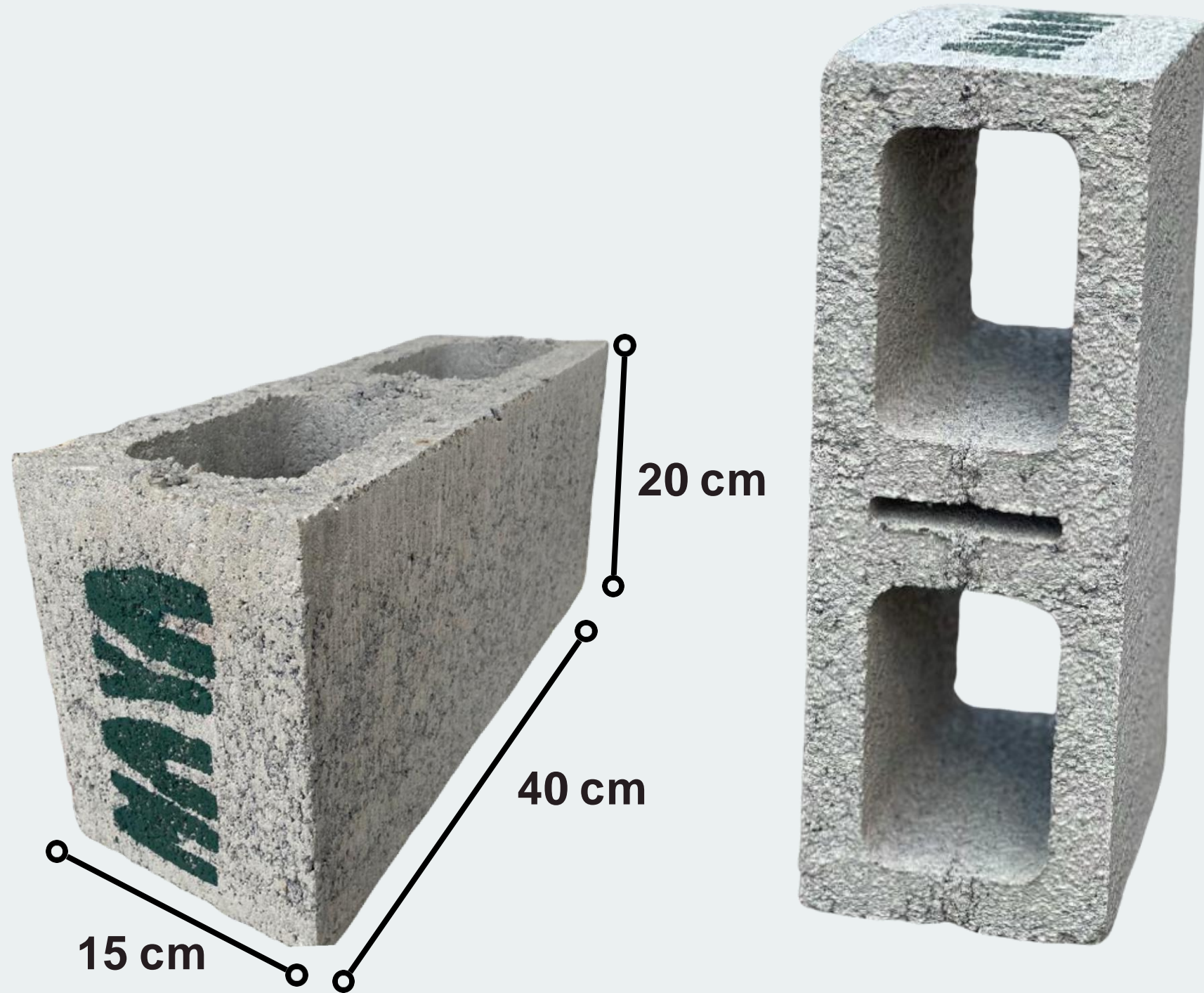

BLOCK CLASE C



Datos Técnicos

<i>Dimensiones</i>	15x20x40 cm.
<i>Resistencia área Bruta</i>	35 kg/cm ²
<i>Resistencia área Neta</i>	66 kg/cm ²

Envío



	<i>camión un eje</i>	1,000 unidades
	<i>camión doble eje</i>	1,500 unidades
	<i>Rastra</i>	3,000 unidades

BLOCK 19x19x39 cm

Datos Técnicos

<i>Dimensiones</i>	<i>19x19x39 cm.</i>
<i>Resistencia área Bruta</i>	<i>35 kg/cm²</i>
<i>Resistencia área Neta</i>	<i>66 kg/cm²</i>

Envío

	<i>camión un eje</i>	<i>500 unidades</i>
	<i>camión doble eje</i>	<i>1,000 unidades</i>
	<i>Rastra</i>	<i>2,500 unidades</i>

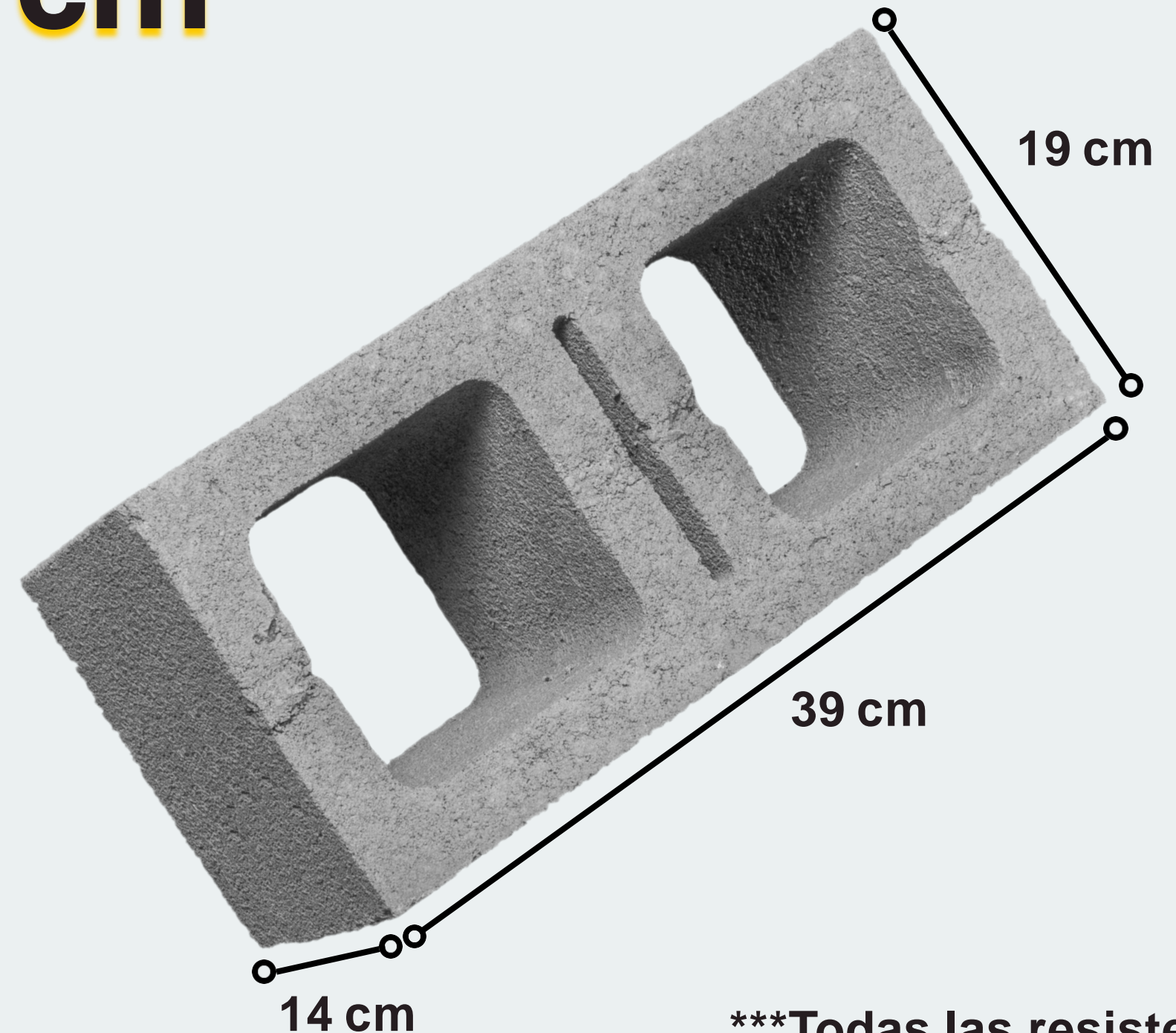

***Todas las resistencias

M A Y A B L O C K S . A .

BLOCK TIPO SOLERA

Datos Técnicos

<i>Dimensiones</i>	<i>15x20x40 cm.</i>
<i>Resistencia área Bruta</i>	<i>35 kg/cm²</i>
<i>Resistencia área Neta</i>	<i>66 kg/cm²</i>

Envío

	<i>camión un eje</i>	<i>1,000 unidades</i>
	<i>camión doble eje</i>	<i>1,500 unidades</i>
	<i>Rastra</i>	<i>3,000 unidades</i>

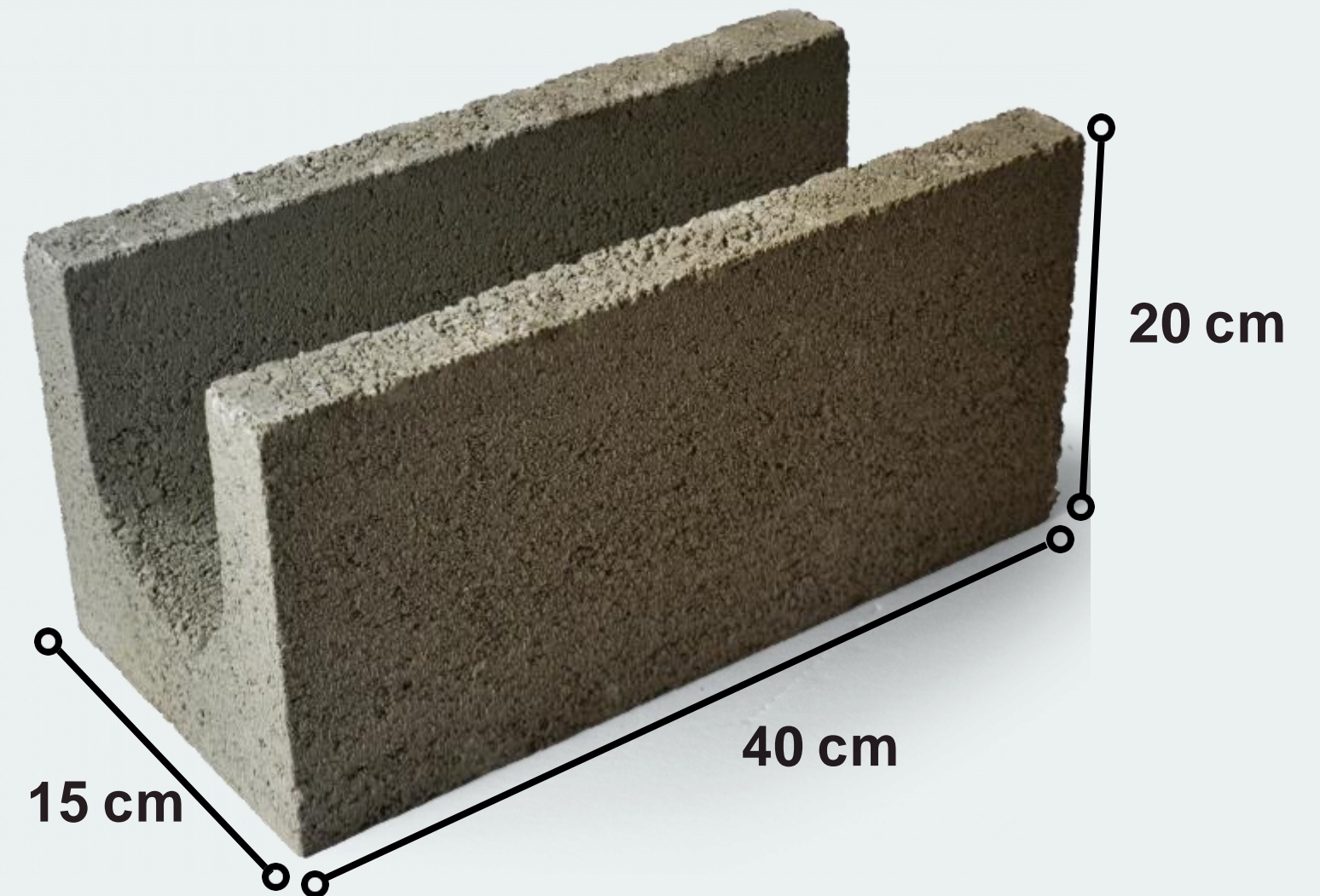

BLOCK 10x20x40 cm

Datos Técnicos

<i>Dimensiones</i>	<i>10x20x40 cm.</i>
<i>Resistencia área Bruta</i>	<i>35 kg/cm²</i>
<i>Resistencia área Neta</i>	<i>66 kg/cm²</i>

Envío

	<i>camión un eje</i>	<i>1,000 unidades</i>
	<i>camión doble eje</i>	<i>2,000 unidades</i>
	<i>Rastra</i>	<i>4,000 unidades</i>

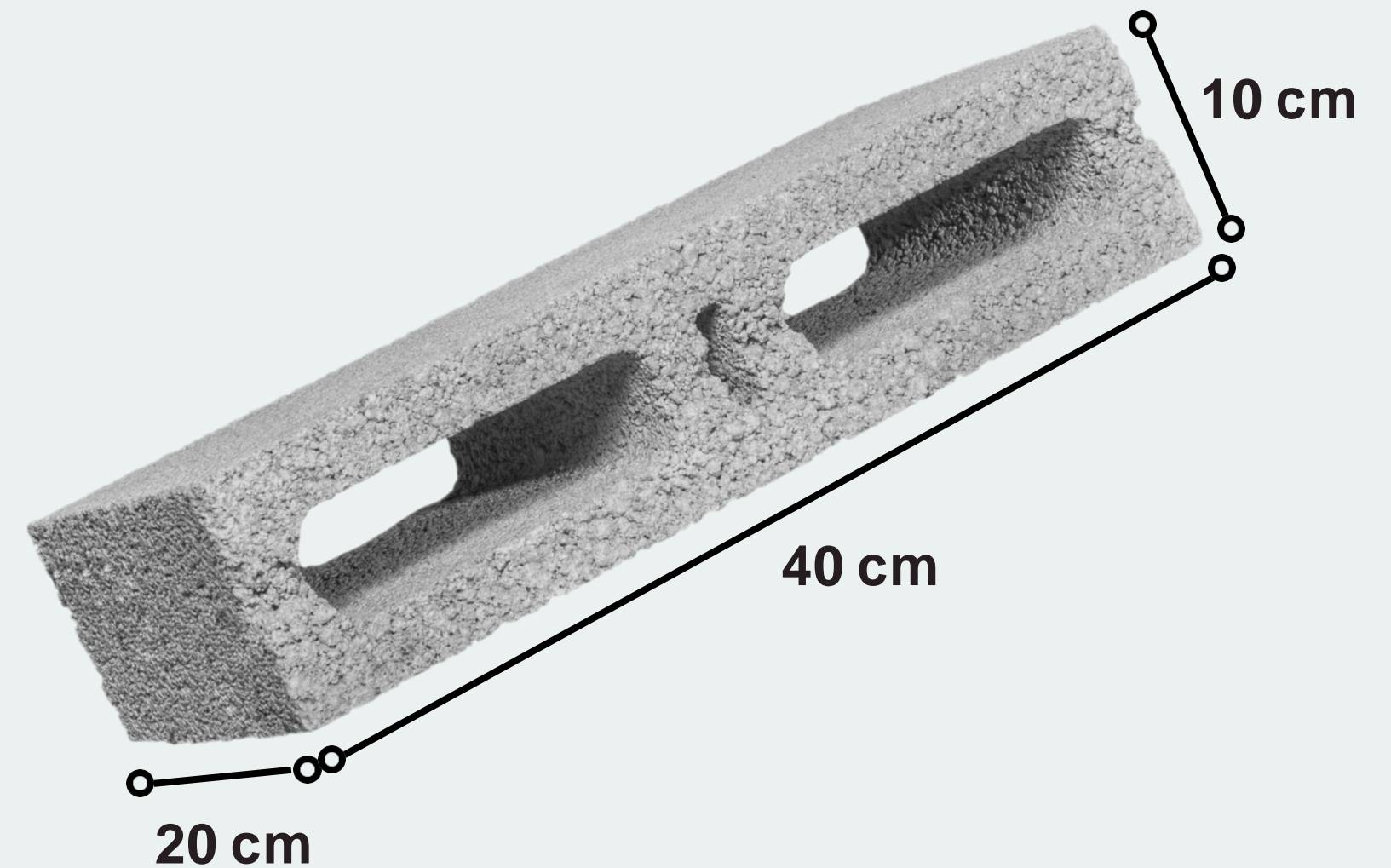

M A Y A B L O C K S . A .

Síguenos



WHATSAPP

3038-7504
5510-1075
3687-9206



FACEBOOK

MAYA BLOCK SA



INSTAGRAM

@MAYABLOCKCHIQUIMULA

CONTACTA CON NOSOTROS

DIRECCIÓN

Km. 163 Aldea El Ingeniero, Chiquimula.

Km. 152 Aldea El Tempisque, Gualán, Zacapa.

Km. 177 San Manuel Chaparrón, Jalapa.

TELÉFONO

3038-7504 Chiquimula.

5122-2660 Tempisque, Zacapa.

5510-1075 Asesora de Ventas Berta Julia Martínez

CORREO ELECTRÓNICO

mayablockchiquimula@gmail.com

mayablock1@gmail.com